

# Appendix B

## Logistics Standard

Policy for the Logistical  
Binding of Material Suppliers

## Table of Contents

<b>1</b>	<b>Area of Application and Purpose</b>	<b>4</b>
1.1	Scope of Application	4
1.2	Validity	5
1.3	Confidentiality	5
1.4	Obtainability	5
1.5	General Overview of the Procedure for Determining Logistics Costs	5
<b>2</b>	<b>Production Capacity</b>	<b>7</b>
<b>3</b>	<b>Supply Systems</b>	<b>7</b>
3.1	Call-off and Ordering Process	7
3.2	Checking Delivery Call-offs	8
3.3	Delivery Quantities	8
3.4	Electronic Data Interchange EDI	9
3.5	Use of a Regional Warehouse	9
3.6	Credit Note Procedure/Invoicing	10
3.7	Supply Systems and Dispatch Control	10
3.7.1	Stock Procurement Supply System	10
3.7.2	Vendor Managed Inventory (VMI) Supply System	11
3.7.3	eKanban Supply System	12
3.7.4	JIS (Just In Sequence) Supply System	13
3.7.5	Supply by Single Procurement	14
3.8	Keeping of Safety Stocks	14
3.9	On-time Delivery	14
<b>4</b>	<b>Packaging</b>	<b>15</b>
4.1	Delivery Regulations	15
4.2	Development of Special Load Carriers	15
4.3	Specification and Use of the Packaging	15
4.4	Procurement of Reusable Packaging	16
4.4.1	Approval of the Reusable Packaging	16
4.4.2	Load carrier requirement calculation	17
4.5	Maintenance of the Load Carriers	18
4.6	Storage and Container Availability of the Load Carriers	18
4.7	Packaging After Sales	19
4.8	Scrapping of Containers	19
4.9	Disposal of Disposable Packaging	19
4.10	Empty Packaging Control	19
<b>5</b>	<b>Identification and Labelling</b>	<b>20</b>
5.1	Identification of Pilot Series Parts	20
5.2	Identification of Series Parts	22
5.3	Labelling Changed Parts	22
<b>6</b>	<b>Delivery Process</b>	<b>22</b>

<b>6.1</b>	<b>Delivery Conditions according to the Incoterms® 2020</b>	<b>23</b>
<b>6.2</b>	<b>Transport Responsibility of the Supplier for Incoterm DAP/ DDP</b>	<b>23</b>
6.2.1	Loading and Unloading	23
6.2.2	Special Trips	23
6.2.3	Transport Carriers	24
<b>6.3</b>	<b>Transport Responsibility at SMP for Incoterm EXW/ FCA</b>	<b>24</b>
6.3.1	Notification to the Freight Carrier for Standard Trips	24
6.3.2	Loading and Unloading	24
6.3.3	Shortfall	24
<b>6.4</b>	<b>Transport Responsibility CIP Provision</b>	<b>25</b>
<b>6.5</b>	<b>Loading Plan</b>	<b>25</b>
<b>6.6</b>	<b>Transport Documents</b>	<b>25</b>
6.6.1	Bond Note/Delivery Note	25
6.6.2	Customs Documents	25
6.6.3	Freight Bill	27
<b>6.7</b>	<b>Time Windows</b>	<b>27</b>
<b>6.8</b>	<b>Overdelivery/Underdelivery</b>	<b>27</b>
<b>6.9</b>	<b>Late Deliveries and Delivery Default</b>	<b>27</b>
<b>6.10</b>	<b>NOK Parts</b>	<b>28</b>
<b>6.11</b>	<b>Billing Interval</b>	<b>28</b>
<b>7</b>	<b>Part Redemption</b>	<b>28</b>
<b>8</b>	<b>Information Obligation</b>	<b>28</b>
<b>9</b>	<b>Quality and Logistical Supplier Evaluation</b>	<b>29</b>
9.1	Number of Special Trips	29
9.2	Overdelivery/Early Delivery	29
9.3	Underdelivery/Late Delivery	30
9.4	Logistical Delivery Quality	30
9.5	Response Time	31
9.6	Informational Binding and Soft Facts	31
9.7	Self-evaluation based on Global MMOG/LE	31
<b>10</b>	<b>Logistic Offer Preparation</b>	<b>32</b>
10.1	Definition and Delimitation A Price, B Price and Logistics Costs	32
<b>10.2</b>	<b>Elements of the A Price</b>	<b>32</b>
10.2.1	Handling Expenses	32
10.2.2	Quality Assurance Measures	32
10.2.3	Administrative Activities	32
<b>10.3</b>	<b>Elements of the Logistics Costs</b>	<b>33</b>
10.3.1	Freight Costs	33
<b>10.4</b>	<b>Load Carrier Costs</b>	<b>33</b>
10.4.1	Costs for External Storage and Handling	33
<b>10.5</b>	<b>B Price Inquiry Process</b>	<b>34</b>
<b>10.6</b>	<b>Composition of A and B Price without Use of Regional Warehouse</b>	<b>35</b>
<b>10.7</b>	<b>Composition of A and B Price with Use of Regional Warehouse</b>	<b>35</b>
<b>11</b>	<b>Other Documents</b>	<b>36</b>

<b>12 Terms and Abbreviations.....</b>	<b>37</b>
--	-----------

## **1 Area of Application and Purpose**

The logistics standard regulates the logistical binding of material suppliers to SMP Deutschland GmbH as well as all associated companies of the SMP corporation in the sense of § 15 German Stock Corporation Act (AktG), hereinafter referred to as SMP.

The requirements contained therein are guided by the currently necessary prerequisites for the development of stable logistical processes between the supplier and the SMP factories in the sense of a permanent cooperative partnership.

The logistics standard is an integral part of the SMP purchasing terms and defines the required logistic service scope for the offer price.

A separate article-related calculation data sheet is used for determining prices for freight and packaging costs.

Other process-relevant issues (e.g. emergency concept, contacts and availability, delivery window in the incoming goods department) will be added to the logistics standard after contract placement for the service scope within the framework of a logistics agreement.

SMP is guided by the currently practised standard delivery systems in the automotive industry.

These are:

- stock procurement
- VMI (Vendor Managed Inventory)
- eKanban
- JIS (Just In Sequence)

A detailed description can be found in the chapter on supply systems and dispatch control. The VDA recommendation 5010 also provides an overview.

The decision for a specifically implemented supply system depends on the logistics process with the least possible costs. The stock procurement, VMI and KANBAN supply systems at SMP differ basically in the call procedure for dispatch control at the supplier's. SMP demands willingness for cost-neutral application and implementation of these systems from the supplier.

The JIS supply system requires a separate logistics specification for the price indexing.

Abbreviations and terms are explained in section 11 and are recognisable by CAPITALS the first time that they appear.

### **1.1 Scope of Application**

The logistics standard is valid for all sites of SMP Deutschland GmbH as well as all associated companies of the SMP corporation in the sense of § 15 German Stock Corporation Act (AktG), hereinafter referred to as SMP. The logistics standard must be implemented for all suppliers who provide the service scopes in the sense of production-relevant materials (e.g. production material,

packaging material) or tools for SMP. No distinction is made here whether the service scope was contracted directly by an OEM or by SMP.

If these requirements stand in contradiction to other regulations – unless specified otherwise – the legal requirements shall apply.

## 1.2 Validity

The version of the logistics standard in use respectively at the time of the inquiry is valid. The requirements can be adapted to changing processes in the interests of the continuous improvement process. Later changes require a written agreement between the supplier and SMP. The logistics standard is valid as of conclusion of contract.

## 1.3 Confidentiality

SMP and their suppliers undertake to treat the commitments and agreements made as well as the appropriate documents confidentially. It is agreed to actively provide the partner with important information.

## 1.4 Obtainability

Other applicable documents and forms for the logistics standard such as logistics data sheet, packaging data sheet, packaging directive, load carrier catalogue, EDI GUIDELINE and dispatch instructions can be downloaded in their respective latest version from the SMP website [www.smp-automotive.com/de/suppliers](http://www.smp-automotive.com/de/suppliers) and the supplier portal PriSMa.

## 1.5 General Overview of the Procedure for Determining Logistics Costs

### Components:

#### Prior to assignment:

Logistics standard	Applies generally for all service scopes and is listed as a reference in the purchased parts requirement specification other applicable documents and detailed description: EDI-Guideline: Requirements for the VDA recommendations for VDA goods labels (4902), RDT bond note (4912) and delivery note RDT (4913) Packaging directive: Criteria to be considered in the packaging development	for all service scopes
Purchased parts Requirements specification	Defines the supply system and contains the correct parameter data for price indication by the suppliers	per component group
Calculation sheet Logistics	Appendix to the purchased parts requirement specification (Excel calculation table). Contains detailed specifications for the determination of container and freight costs as well as costs of a regional warehouse	per component group

#### After assignment:

Logistics agreement	Based on the logistics standard	for all service scopes
	Logistics data sheet: Based on the logistics standard and the logistics costs calculation sheet. The container rotation days are defined and further details of the logistical binding agreed (delivery frequency, opening times in IG, min. - max. stocks)	per supplier/sub-assembly
	Packaging data sheet: Describes the used packaging in detail	per component group
	Emergency concept: A concept must be established how a delivery is to be made in an "emergency", i.e. when there are problems with the actual delivery.	per component group

## General Overview: Process for determining the logistics costs

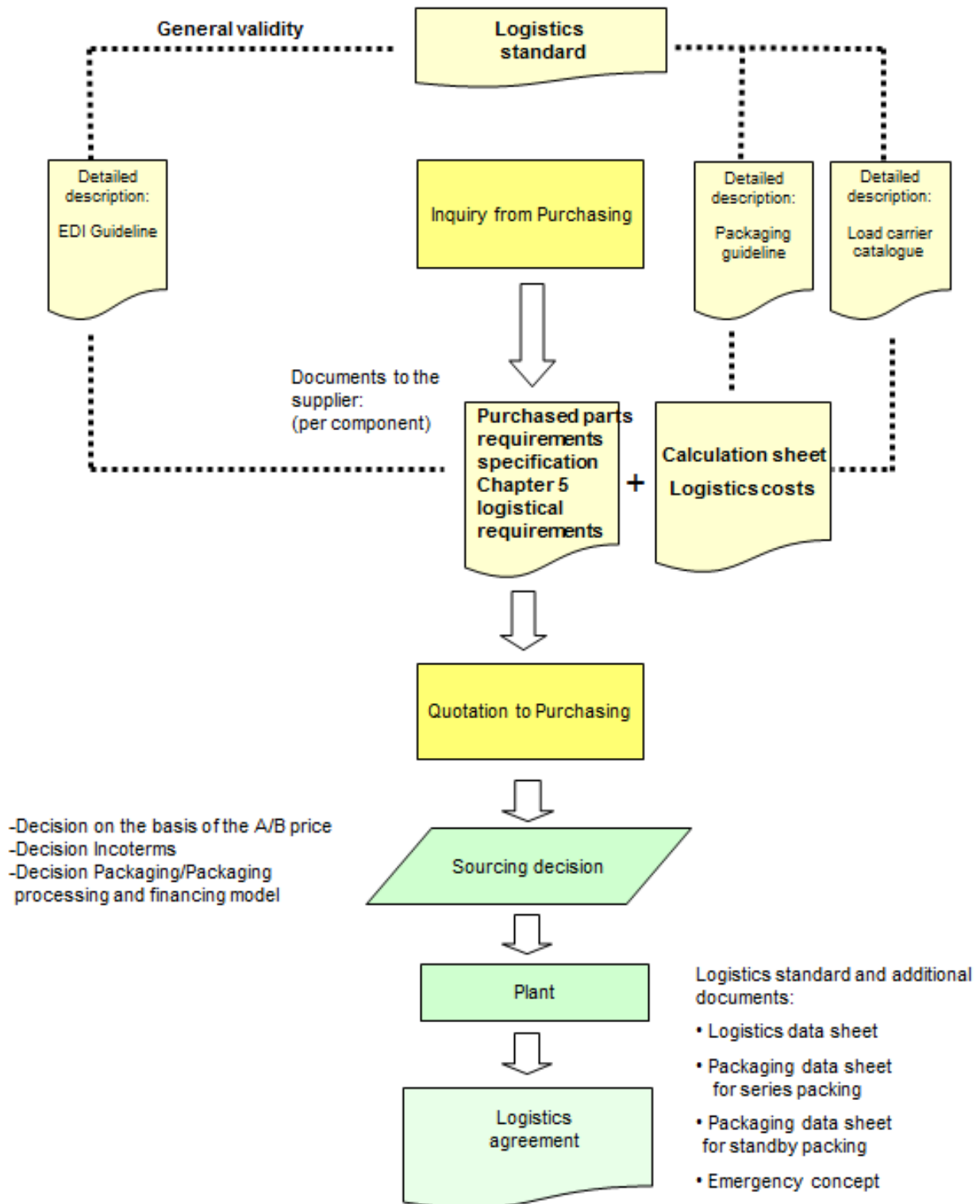

## 2 Production Capacity

The supplier must ensure that appropriate capacity and resource planning is made in all stages of the product cycle (pilot series to after-sales) to be able to deliver the necessary requirements including fluctuations on time.

In order to monitor the named and provided production capacities, both the non-binding requirement forecasts and the binding requirement data must be considered in the delivery schedule for the entire forecast range.

SMP must be notified of production and delivery bottlenecks (also from other suppliers and partners in the supply chain) by suppliers in good time. The time schedule for transport to the relevant SMP factories must be taken into consideration here.

At the time of contract conclusion, the supplier is obliged to announce the average and maximum weekly capacity planned for SMP. The necessary measures for achieving the maximum weekly capacity must also be stated. The suppliers must accommodate to permanent quantity increases/reductions of 15% based on the average weekly capacity within a period of notice of one month in the standard. If SMP makes different demands on the supplier's capacity flexibility, this shall be agreed separately (see logistics agreement).

Suppliers who have production contracts with SMP must always be able to provide aftermarket and service components for individual parts and assemblies for a period of fifteen years after the end of the program or production, or for longer or shorter periods if specified by the relevant OEM customer of SMP's program and communicated to the supplier. Supplier shall be responsible for maintaining all tooling and/or assembly supplies in good condition to meet service requirements. Service schedules and pricing will be negotiated with the procuring plant.

## 3 Supply Systems

SMP incorporate their suppliers into standardised processes of material procurement. An overview and classification of the present standard delivery forms in the automotive industry can be found, for example, in the VDA recommendation 5010.

SMP implements the following supply systems:

1. stock procurement
2. Vendor Managed Inventory (VMI)
3. eKanban
4. just in sequence (JIS)

The call-off and ordering process is identical for all supply systems.  
The supply systems differ in the dispatch control at the supplier's.

### 3.1 Call-off and Ordering Process

The suppliers receive a daily or weekly delivery call-off in accordance with VDA 4905. The article-specific call-off consists hereby of several delivery consignments which contain further data regarding delivery quantities and delivery dates.

The SMP factory normally forecasts its requirements for several months in a preview. The call-off/preview contains

- a fixed period with daily requirements
- a predictive period with weekly and monthly requirements

The necessary procedure for establishing a RDT connection is described in the SMP EDI Guideline.

The requirement preview does not oblige SMP to take delivery, represents no entitlement to delivery and is independent of the supply system.

SMP reserves the right to increase, reduce or cancel call-offs at short notice. The last transferred call-off is valid and overwrites any previous ones.

The delivery note number of the last goods receipt applies as a delimitation.

## 3.2 Checking Delivery Call-offs

The incoming delivery call-offs must generally be confirmed by the supplier. The respective confirmation can be omitted if the EDI send/receive report is accepted by SMP as confirmation of receipt (see logistics agreement).

The supplier shall regularly check the receipt of delivery call-offs as well as their plausibility and viability. They will report on their own accord if there are any doubts about the data. First, objection to the delivery call-off must be raised in writing to the expeditor responsible within the following specified period.

The following periods of objection apply:

- For call-off changes in the long-term period (> 10 work days) within 3 days
- For call-off changes in the short-term period (< 10 work days) within 24 hours

The delivery call-off shall be considered agreed and binding when the delivery call-off is not objected to in writing within the above-mentioned deadlines. The objection must be confirmed by SMP in writing.

Changes in the quantity or date after transfer of the call-off by the supplier can only be made in writing and must be confirmed by SMP in every single case. The expeditor will state the cause for a probable delivery delay and name a subsequent delivery date. Rights of claim for delivery default remain unaffected hereby.

## 3.3 Delivery Quantities

The delivery quantity call-off by dispatch control is made according to the agreed delivery lot size.

In the event of a change in the index state of an article code (change index) and a change in the whole article code, the lot size agreed in the logistics data sheet can be dissolved and called off to the exact unit by the expiry date to avoid over-delivery. The call-off quantities follow those of the respective SMP customer.

Quantity exceedances by pair-wise deliveries (e.g. left, right) are generally not allowed. The respective call-off per article code applies.



## 3.4 Electronic Data Interchange EDI

The use of electronic data interchange enables the setup of low-administration business processes as well as the avoidance of transmission errors.

The use of the electronic data interchange and the appropriate documents is mandatory for suppliers to SMP and must be implemented cost-neutrally. SMP uses VDA recommendations. To be mentioned here in particular are the VDA standards on delivery call-off (4905), dispatch advice (4913), VDA goods tags (4902) and bond notes (4912). EDIFACT notification DELORD for the KANBAN handling is also used.

See the SMP EDI Guideline for details on the use of the electronic data interchange. If the supplier has no possibility of direct links via VDA protocols, handling by the internet platform (Web EDI) approved by SMP is possible. Alternatively, in individual cases and in agreement with the supplier, appropriate Odette or EDIFACT standards can be used.

Once the delivery has left the dispatch warehouse, an advance shipping notice (ASN) must be sent to the material planner and/or responsible contact at the factory within 30 minutes. If a delivery bottleneck or delay in delivery becomes apparent, the supplier must contact the SMP factories concerned immediately to inform them. In addition, the supplier must provide information about when the special delivery of the ordered material can be expected in order to be able to keep to the original time schedule. This notification is essential in order to inform production and SMP's customer if necessary.

In the case of obligatorily batched purchased parts, the design revision state must always be entered in the EDI in the batch field (in set type 716, item 03), otherwise items will be untraceable. (See the EDI-Guideline for this) Which purchased parts are always batched must be agreed with the responsible buyers.

## 3.5 Use of a Regional Warehouse

In the interests of a TLC (total landed cost) optimisation and to safeguard the supply, it may be useful for suppliers, especially those outside Europe, to set up a regional warehouse close to an SMP factory.

SMP maintains no own regional warehouses. Handling through a regional warehouse is the supplier's responsibility. SMP cooperates with several service providers in this respect and also offers support with the implementation in individual cases. Consignment or sequencing activities can be carried out in the regional warehouse in addition to the keeping of safety stocks to guard against supply risks. Important here is the observance of the distinction between the A price and the B price (see also chapter 9 Logistic Offer Preparation).

The respective supply systems are used independently of this. However, the eKanban and JIS supply systems are used preferably in connection with a supplier warehouse.

### 3.6 Credit Note Procedure/Invoicing

Delivered GOODS are paid by credit note in accordance with VDA 4908.

### 3.7 Supply Systems and Dispatch Control

#### 3.7.1 Stock Procurement Supply System

Overview:

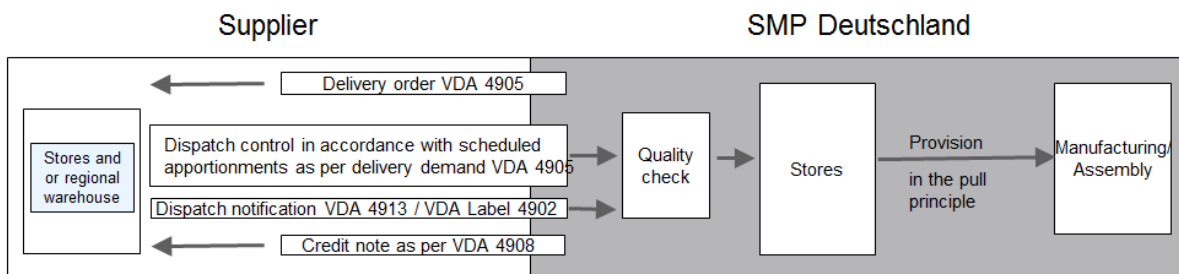

**Call-off:**

The 'stock procurement' supply system is the only handling procedure in which the call -off according to VDA 4905 is not only interpreted as a preview but also entitles to delivery. The call-off therefore serves for dispatch control at the supplier's within the specified time period.

In the VMI, eKanban and JIS supply systems, the call-off is used for resource planning and pre-material procurement at the supplier's.

Dispatch is controlled by additional information.

**Dispatch quantities:**

The dispatch quantities which entitle to delivery on the respective dates are identified in the call-off.

The dates in the call-offs are delivery dates at SMP. The supplier must ensure that the called part scopes are provided to the freight forwarder on time and in the right quantity to keep the delivery date.

The respective specified quantities and dates must be kept in all cases regardless of statutory and religious holidays and national restrictions.

The transfer of risk from the supplier to SMP is regulated depending on the agreed Incoterms. For FCA deliveries, these are after loading onto the provided trucks, for DDP on unloading the goods from the truck.

**Goods collection:**

Collection of the delivery quantity is made based on the electronic dispatch advice in accordance with VDA 4913 as well as the appropriate VDA goods tags in accordance with VDA 4902. The structure of the individual messages is described in the SMP EDI Guideline. The supplier must ensure that the loaded quantities match the specifications on the RDT bond note in accordance with VDA 4912 and the electronic dispatch advice before arrival of the truck at SMP.

**Incoming goods inspection:**

Dynamic random sample testing takes place in the incoming goods department. This does not release the supplier from a 100% OK product quality (see also chap. 8).

**Transfer of ownership:**

The material in the SMP warehouse is the property of the supplier. Consignment handling is generally assumed. SMP undertakes to maintain proper storage. Ownership is transferred from the supplier to SMP after withdrawal of the materials from the consignment warehouse.

**Delivery service assessment:**

The basis for assessment is the last valid call-off. The assessment is made based on the actual delivery dates with regard to the delivery dates and delivery quantities in the last valid call-off.

**3.7.2 Vendor Managed Inventory (VMI) Supply System**

**Overview:**

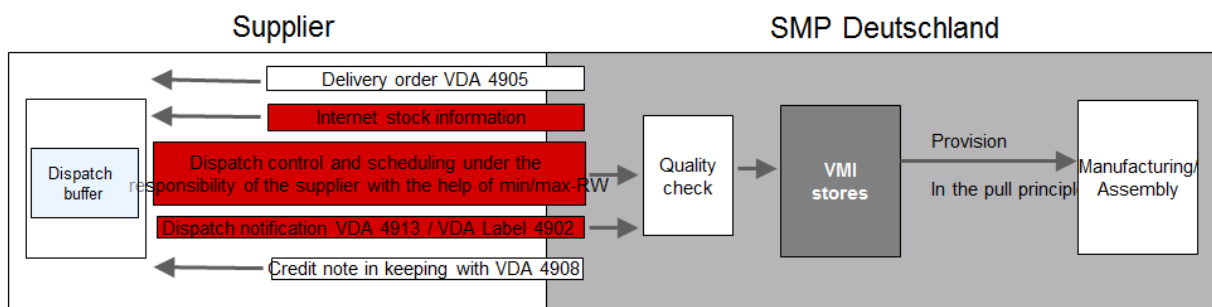

**Call-off:**

Like for all supply systems, the call-off serves for resource planning and pre-material disposition at the supplier's. The data in the call-off are always net data, i.e. the warehouse stocks in the VMI warehouse are already cleared. The call-off does not entitle to delivery.

**Dispatch quantities:**

SMP provide their suppliers with the latest net planned requirements, warehouse stocks, consumed quantities and information about the last delivery daily on the Internet. The maximum and minimum stock scopes are defined in SMP's VMI tool. The scopes are defined in relation to the articles in the logistics agreement together with the supplier based on the defined delivery batch sizes and delivery cycles.

SMP reserves the right to adapt the scopes depending on the supplier performance.

The min./max. stocks indicated in the VMI tool are binding for the dispatch control at the supplier's. Delivery is made within the specified min./max. stocks under consideration of the production and material releases. It is not permitted to exceed or drop below these; this also applies for article code pairs (e.g. left, right).

A delivery to the VMI warehouse of material outside the production release is not permitted and will be sent back at the expense of the supplier.

**Incoming goods inspection/goods collection/transfer of ownership:**

The processes are the same as in the stock procurement supply system (see 3.7.1). SMP will bear the costs for material handling in connection with the VMI warehouse as well as for the warehouse capacity provided. Details on the VMI supply system are described in the VMI-Guideline.

**Delivery service assessment:**

The basis for the assessment are the mutually agreed min./max. limits. The assessment is made based on exceeding or falling below the respective min./max. limits.

**3.7.3 eKanban Supply System**

**Overview:**

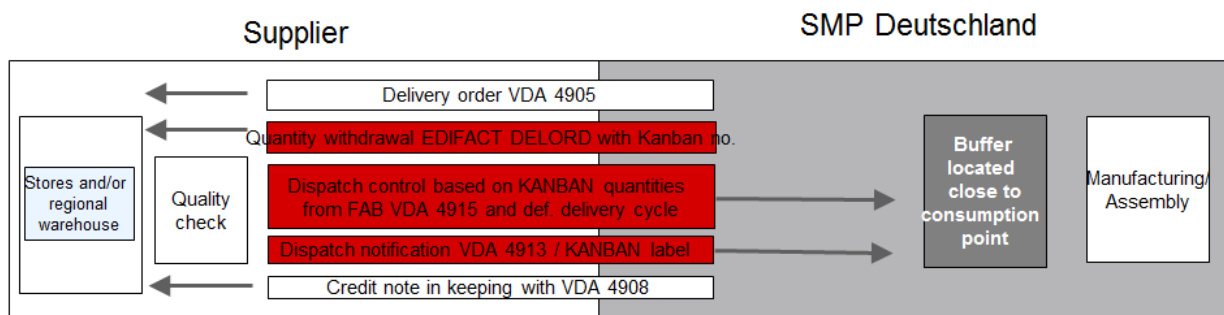

The supply system is implemented after mutual definition of the system parameters procurement time, Kanban batch size and transport cycle with the supplier. The Kanban supply system is a warehouse-free process. This means that no consignment store will be set up at SMP. There is therefore no consignment handling. Merely a Kanban buffer stock is kept near to where it is consumed.

The buffer stock is the property of SMP. Due to the omission of warehousing, the Kanban handling assumes 100% OK quality and the keeping of a safety stock at the supplier's.

**Call-off:**

Like for all supply systems, the call-off serves for resource planning and pre-material disposition at the supplier's. The call-off does not entitle to delivery.

**Dispatch quantities:**

A quantity call-off according to EDIFACT DELORD is transferred for the dispatch control. This quantity call-off contains the required Kanban quantities. A unique Kanban number is transferred per Kanban. The supplier must state this Kanban number in place of the package number in the dispatch advice (VDA 4913).

**Incoming goods inspection:**

The goods are delivered directly to a production buffer store. No separate random sample testing takes place. The supply concept is based on the delivery of 100% product quality. Separate agreements are made with the Quality Assurance department for this.

**Goods collection:**

Goods collection takes place analogously with the stock procurement process.

**Transfer of ownership:**

The transfer of ownership is governed by the agreed Incoterms (DDP/FCA).

**Delivery service assessment:**

The basis for assessment are the called Kanbans in the agreed procurement time. The assessment is made based on the Kanban not delivered on time in relation to the called Kanban.

### 3.7.4 JIS (Just In Sequence) Supply System

**Overview:**

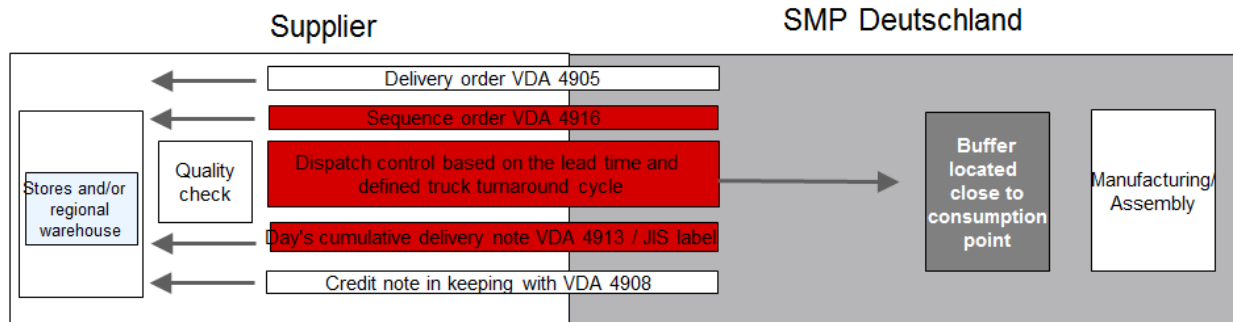

A separate JIS requirement specification is compiled for the price indexing based on a JIS supply. The central part of the JIS requirement specification is the control time diagram.

**Call-off:**

Like for all supply systems, the call-off serves for resource planning and pre-material disposition at the supplier's. The call-off does not entitle to delivery.

**Dispatch quantities:**

Dispatch at the supplier's takes place based on the JIS call-off according to VDA 4916 and on the basis of the basic diagram.

**Incoming goods inspection:**

The goods are delivered directly to a production buffer store. No separate random sample testing takes place. The supply concept is based on the delivery of 100% product quality. Separate agreements are made with the Quality Assurance department for this.

**Goods collection:**

Goods collection takes place analogously with the stock procurement process.

**Transfer of ownership:**

The transfer of ownership is governed by the agreed Incoterms (DDP/FCA).

**Delivery service assessment:**

The assessment takes place based on individual non-delivered components.

### 3.7.5 Supply by Single Procurement

**Overview:**

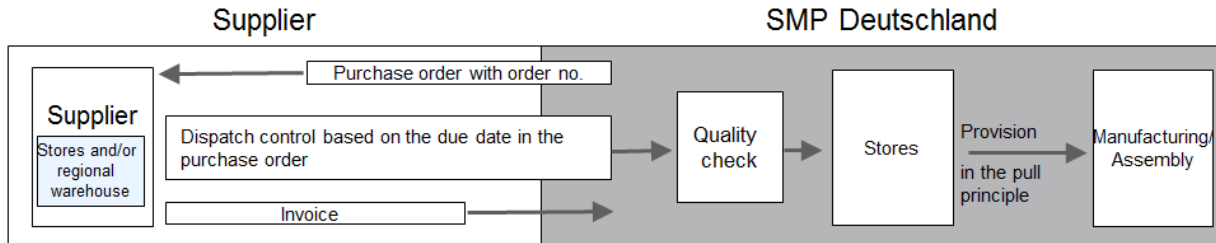

Supply by 'single procurement' regulates the delivery of service scopes for which no delivery plans are available. This represents a procurement process directed at the current situation. In this respect, this cannot be referred to as a supply system.

The orders are unique, possibly sporadic, as a rule. For single procurements, the definition of the logistical details with the aid of the logistics agreement is dispensed with. SMP is responsible for conveying all the necessary requirements and information with the order (delivery quantity, packing batch, load carrier, packaging, labelling, if necessary, transport service provider, delivery documents, etc.).

The supplier receives no requirement preview according to VDA 4905 for a single procurement. The supplier receives the orders by fax or by post. In turn, the supplier must confirm the order immediately.

### 3.8 Keeping of Safety Stocks

Suppliers must keep a sufficient safety stock and supply of end products to be able to ensure on-time delivery. The stocks defined in the supply systems are adapted to the delivery batch sizes and serve to cover short-term requirement fluctuations. The stocks are not intended for safeguarding delivery delays of the supplier.

The supplier is therefore responsible for on-time delivery to SMP and must keep their own safety stocks of finished or semi-finished parts to ensure this if necessary. The volume and location of the stockage depends on

- the stability of the supplier's internal processes
- the stability of the logistics chain prior to the supplier
- the geographical distance of the supplier when a regional warehouse is used

The supplier is obliged, on demand by SMP, to report their current safety stock coverage.

### 3.9 On-time Delivery

The specified quantities and dates must be kept at all cost regardless of statutory and religious holidays or national restrictions. Short deliveries must be reported immediately to SMP with a corrective measure and emergency plan. All costs incurred due to missed or late deliveries by the supplier will be charged to the supplier. The supplier must ensure the supply of parts even in the absence of empty packaging and must use the specified alternative packaging, if necessary, after prior agreement with the SMP factory.

## 4 Packaging

### 4.1 Delivery Regulations

The supplier must pack the containers homogeneously (i.e. **separately according to** batch, part generation state, part number, different country or origin, storage locations and unloading points); different part generation states of a product may not be combined in one package. The individual packages must be put together in a loading unit safe for transport and secured against slipping during transport.

When delivered on pallets, the top layer must be level. If the number of parts to be packed does not allow a stackable surface to be formed, empty containers should be used to fill up the gaps, if necessary, under consideration of the static and dynamic stacking factor. (See the Packaging Guideline.)

Regardless of the choice of packaging type the maximum height dimension of the pallets is 1000 (mm) and cannot be exceeded

### 4.2 Development of Special Load Carriers

The development, financing and procurement of special load carriers is the responsibility of the supplier. The SMP Packaging Guideline must be observed for this. This defines according to what criteria a packaging is to be developed. Every new special load carrier and every modification to a special load carrier must be agreed with and approved by SMP.

Disposable packaging will also be developed and paid by the supplier. Universal load carriers are considered as special load carriers with permanently connected, part-specific liners.

The necessary investments and depreciations as well as maintenance, cleaning and servicing of the special load carriers are agreed in writing according to an agreed refinancing model at conclusion of contract. The calculation is made based on the logistics costs calculation sheet.

### 4.3 Specification and Use of the Packaging

The packaging used between the supplier and the respective SMP factory and the associated responsibility must be defined in detail and confirmed after conclusion of contract by means of the packaging data sheets. Confirmation must be given at the time specified in the project schedule. The supplier's tool costs will only be cleared after acceptance of the series packaging by SMP.

The packaging data sheet must also be sent to SMP for clearance in case of redefinition or modification of a packaging by the supplier. Deviations from the specified load carrier are only permitted after prior consent in written form by the responsible expeditor or packaging planner of SMP. The consent must include the item numbers concerned as well as the alternative packaging and the exact time period of the clearance. Deliveries in unapproved alternative packagings will be subject to test report costs.

SMP expects the goods delivery exclusively in undamaged and clean load carriers.

The load carriers are intended for transporting the series purchased parts between the supplier and SMP and may not be misappropriated, e.g. for

- the internal production cycle at the supplier's

- intermediate storage of semi-finished parts
- pre-production

If the supplier relocates their production and/or collection address for the components and/or changes their processes, more reusable containers could be required. This extra requirement must be covered by an investment, procurement and provision of the containers by the supplier at the time of the relocation at the latest. SMP will not bear the incurred costs in this case.

## 4.4 Procurement of Reusable Packaging

The supplier shall provide SMP Logistics with proof of full reusable packaging procurement [delivery note and/or invoice]. All reusable packagings required for goods traffic circulation between the supplier and SMP will be recorded and managed in leased goods accounts. The supplier must compile and manage the appropriate records and present these to SMP on demand. The supplier must ensure that all receipts and dispatches are booked.

### 4.4.1 Approval of the Reusable Packaging

The following milestone plan describes the procedure for approving reusable packaging:

1. The first written packaging concept [supplier] shall be sent at the latest 4 CW after the CAD data for the component were approved [SMP].
2. An initial physical packaging sample [supplier] maximum of 6 CW after the availability of the first components [supplier]. All changes must be implemented in the sample within a maximum of 3 CW and agreed with SMP.
3. Any necessary offer relating to a change in the packaging (CBD) [supplier] at the latest 2 CW after final approval of the packaging [SMP]
4. A minimum of 20% of series packaging [supplier] shall be available at the latest 12 CW after SMP has placed an order [SMP]
5. Documentary evidence of 100% available series packaging at the latest 20 CW before SOP. [Supplier].

In the event of non-compliance with the specified time frame, escalation shall be initiated by the responsible buyer.

Preliminary approval of the components (Note 3, yellow sampling,...) shall only take place in conjunction with correct series packaging.



**4.4.2 Load carrier requirement calculation**

The total amount of the required load carriers is composed of:

1. the circulating stock (provision at the supplier and transit) of load carriers between the supplier and the SMP Plant
  - a. Circulating stock for complete truck load
  - b. Circulating stock for general cargo shipments or split loads
2. and the maximum stock level at A depending on the delivery frequency per week.

Please note: The load carriers for the stock at the supplier as well as for the internal production at the supplier including possible further service providers commissioned by the supplier are not part of the logistics costs! The investment costs for this are to be considered in the A-price!

1a. Calculation of the stock in circulation for complete loads

<b>3 WD</b>	Inventory for unloading, packing, loading = <b>Supplier</b>
<b>1 WD</b>	Full load transport to SMP for full loads (Distance < 1000 Kilometer) = <b>Transit</b>
<b>2 WD</b>	Full load transport to SMP for full loads (Distance > 1000 Kilometer) = <b>Transit</b>
<b>1 WD</b>	Empties transport back to the supplier for complete loads (Distance < 1000 Kilometer) = <b>Transit</b>
<b>2 WD</b>	Empties transport back to the supplier for complete loads (Distance > 1000 Kilometer) = <b>Transit</b>

1b. Calculation of the stock in circulation for general cargo (0- 2 loading meters) or partial loads (> 2-10 loading meters).

<b>3 WD</b>	Inventory for unloading, packing, loading = <b>Supplier</b>
<b>2 WD</b>	Full load transport to SMP for general cargo shipments (Delivery address within Germany) = <b>Transit</b>
<b>5 WD</b>	Full load transport to SMP for general cargo shipments (Delivery address outside Germany) = <b>Transit</b>
<b>2 WD</b>	Empties return transport to SMP for general cargo shipments (Delivery address within Germany) = <b>Transit</b>
<b>5 WD</b>	Empties return transport to SMP for general cargo shipments (Delivery address outside Germany) = <b>Transit</b>

2. Maximum total load carrier requirement depending on the delivery frequency per week:

Delivery frequency per week	Load carrier range in WD					
	1x	2x	3x	4x	5x	>5x
Stock at SMP (half as full and half as empty)	10	8	6	4	2	2
<b>Total</b> carrier range for a full truck load (distance < 1000 kilometers):	15	13	11	9	7	7
<b>Total</b> carrier range for a full truck load (distance > 1000 kilometers):	17	15	13	11	9	9
Total carrier range for Piece goods / partial loads (Delivery address within Germany)	17	15	13	11	9	9
<b>Total</b> carrier range for Piece goods / partial loads (Delivery address outside Germany)	23	21	19	17	15	15

Die ermittelten Bestände beziehen sich auf LKW-Transporte!

Examples

The supplier is located in D 650 km away from the recipient plant and has to deliver a full truck (complete load) 3x times a week →

Result: 3 WD (Supplier) + 1 WD + 1 WD (Transit) + 6 WD (Stock SMP) = 11 WD Total stock

The supplier is located in D 650 km away from the recipient plant and has to deliver 2x per week deliver a transport volume of 4 loading meters (piece goods) →

Result: 3 WD (Supplier) + 2 WD + 2 WD (Transit) + 8 WD (Stock SMP) = 15 AT Gesamtbestand

The supplier is located abroad 1260 km away from the recipient plant and has to deliver a full truck (complete load) 1x times a week →

Result: 3 AT (Supplier) + 2 AT + 2 AT (Transit) + 10 AT (Stock SMP) = 17 WD Total stock

The supplier is located abroad 1260 km away from the recipient plant and has to deliver 1x per week deliver a transport volume of 4 loading meters (piece goods) →

Result: 3 WD (Supplier) + 5 WD + 5 WD (Transit) + 10 WD (Stock SMP) = 23 WD Total Stock

**4.5 Maintenance of the Load Carriers**

The supplier must assure that the load carriers are kept in a usable condition. This includes regular thorough cleaning and regular maintenance of the containers. The supplier bears the costs for this.

The packagings must be stored by the supplier in such a way that soiling is ruled out before, during and after the production process.

**4.6 Storage and Container Availability of the Load Carriers**

All containers provided to the supplier must be stored at the supplier’s for the entire delivery period. This also applies for temporary reduction in the quantity. Intermediate storage of the containers at SMP is not possible.

## 4.7 Packaging After Sales

Deliveries by the supplier must be made in an aftersales packaging (single or multi-unit packaging). This must be agreed in writing with the SMP packaging planner in the packaging planning process prior to the first delivery. This aftersales packaging must be packed additionally in reusable containers or in disposable shipping containers depending on the part type and location of the supplier.

## 4.8 Scrapping of Containers

Containers belonging to SMP may only be scrapped in agreement with the respective responsible SMP packing planning. SMP's own containers may not be misappropriated (e.g. for the internal production process at the supplier's, supply of the 2nd tier level or deliveries to our SMP competitors).

## 4.9 Disposal of Disposable Packaging

If disposable packaging is unavoidable, these will be disposed of at the cost of the supplier unless agreed otherwise.

## 4.10 Empty Packaging Control

Storage of empty packaging should be handled as follows:

- Universal containers (VDA-SLC without part-specific liners, EUR skeleton boxes) will be allocated to the suppliers depending on the purchased part call-offs.
- Special load carriers will be stored generally at the supplier's so that the parts can be delivered in the agreed packaging for short-notice call-offs.

The supplier is responsible for on-time call-off of empty packaging at the allocated SMP factory. The empty packaging requirement is defined dependent on the load carrier requirement planning in the logistics agreement. Return to the supplier takes place according to the delivery cycle insofar as no other agreements have been made.

Poolable load carriers (skeleton boxes and EURO flat pallets) will be exchanged immediately with the freight forwarder on collection or delivery of the shipment. Accounts are kept with the freight forwarder.

Non-poolable load carriers (SLC and special load carriers) are managed by SMP on supplier-related accounts.

For empty packaging management, the supplier will specify the SMP packaging number with the appropriate quantity on the delivery note with every delivery. If exchange pallets are used, these must also be listed on the delivery note.

The supplier will check reusable empty packaging at incoming goods inspection and report any detected defects (e.g. quantity differences, damage) immediately to the SMP contact with specification of the delivery note, photographic evidence and a brief description of the complaint. The further procedure must be agreed with the SMP contact from case to case.

The load carrier accounts of the arrivals and departures are settled monthly with the suppliers. SMP will send a list of all movements for this which must be checked for correctness within 2 weeks. If SMP receives no written complaints by this deadline, the stocks from the statement of account are considered as accepted bindingly by the supplier.

The supplier and SMP will carry out a load carrier inventory every six months on a key date. Each party shall bear their own expenses for this. If a supplier fails to report their inventory stocks by the set deadline, the stocks on the statement of account following the inventory will be considered as accepted bindingly by the supplier.

## 5 Identification and Labelling

### 5.1 Identification of Pilot Series Parts

Every single part must be labelled for samples, prototypes and pilot series parts. All goods tags must be readable and scannable in accordance with the VDA standard (4902) or the regulations specified by the factories.

The positioning, alignment, quality and number of labels must be in accordance with the regulations in VDA standard 4902 unless specified otherwise by the factory-specific requirements.

The following data must be specified on the label **as of the pilot series phase**:

Pre-series / Sample Part 	
Project:	
Part Name	
SMP-Part-No.:	
Customer-Part-No.:	
Material:	
Prod. Date:	
Construction Level :	
V-Level :	

- Specification of the drawing revision index (design state)
- Clear identification as a sample
- Specification of the date of manufacture
- SMP sample part label on the parts
- Approval label of supplier QA on every container/every packing unit
- OEM-specific identification
- S-state

If no bond note can be used in the individual case, e.g. for single special trips, the shipment must include a delivery note with the same data as on the bond note:

1. Delivery address
2. Project designation
3. SMP part number/SMP item number
4. Customer part number/customer item number

5. Material designation/article designation
6. Spraying date
7. Batch
8. Design revision state
9. Quantity
10. Receipt number (for chargeable components)
11. Contact

Example for the identification on the packing unit (PU) - pilot series label:

SMP Deutschland GmbH  
Vorseiercenter  
Umbertshausener Weg 6  
93333 Neustadt/Schwaig



**Project:**

<b>SMP part number:</b> <input style="width: 100%;" type="text"/>	<b>V-Level:</b> <input style="width: 50%;" type="text"/>
<b>Customer part number:</b> <input style="width: 50%;" type="text"/>	<b>Change Level:</b> <input style="width: 50%;" type="text"/>
<b>Part name:</b> <input style="width: 150%;" type="text"/>	<b>Quantity</b> <input style="width: 50%;" type="text"/>
<b>Production date:</b> <input style="width: 50%;" type="text"/>	

**Info to:**  **New part revision:**  yes  
 no

This information must be available on the packaging (box, SLC, container, etc.) and also on the delivery note. Fill in grey fields and check applicable box.

In case of changes to the component (→ "New part version" yes marked), a part life cycle must be included.

Specific data (e.g. OEM specifications) must be observed in the individual case.

The supplier is obliged to keep a parts history according to the QA specification and to mark the parts accordingly and to mark the parts accordingly until the initial sample release with grade "1". The S-grade is also to be attached to the outside of each carton, KLT, container on the goods tag.

### 5.2 Identification of Series Parts

The identification of the packages according to the VDA standard 4902 as well as the appropriate dispatch advice according to VDA 4913 is an important prerequisite for the integrative use of the receipts. According to the VDA standard, every package/every load unit must carry a unique package number.

The exact regulation for identification of the load unit and load carrier (container) as well as the appropriate dispatch advice is described in the SMP EDI Guideline.

In addition, the type of fixation and the position of the label on the load carrier are specified in the respective packaging data sheet. All old labels must be removed before labelling the containers.

### 5.3 Labelling Changed Parts

After making a change to a product, the first three deliveries must be marked clearly “by a warning triangle” with the word “Change” and specification of the relevant change index. It must be immediately visible from the documents/identification whether this is the first, second or third delivery of new production material.

Example to be noted in the delivery note:

Zusätzliches Feld einpflegen!  
Auf dem man erkennen kann, um welche Lieferung es handelt.

---

35040016      181020000000 / 650-0182.00.0- S05  
Halter SWA LI

 1 supply / S05

Obaly: S      KLT (600x400x280) SMP (P6280 )

---

35040016      181020000000 / 650-0182.00.0- S  
Halter SWA LI

 2 supply / S05

Obaly: S      KLT (600x400x280) SMP (P6280 )

---

35040016      181020000000 / 650-0182.00.0- S05  
Halter SWA LI

 3 supply / S05

Obaly: S      KLT (600x400x280) SMP (P6280 )

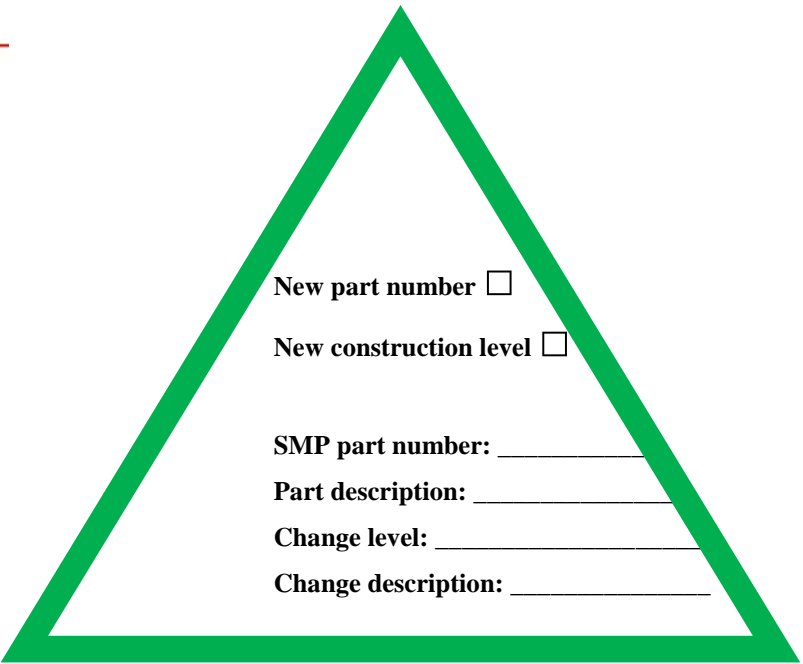

New part number

New construction level

SMP part number: \_\_\_\_\_

Part description: \_\_\_\_\_

Change level: \_\_\_\_\_

Change description: \_\_\_\_\_

## 6 Delivery Process

The basic conditions for transportations are defined in the logistics data sheet.

If the supplier relocates their production and/or collection address for the components and/or changes their processes, the logistics data sheet must be adapted accordingly in agreement with the SMP factory.

## 6.1 Delivery Conditions according to the Incoterms® 2020

Deliveries are made subject to the conditions of the Incoterms® 2020. Deliveries which change countries or a customs union are subject to the respective import/export regulations. In order to define clear responsibilities, SMP prefers the following commercial terms: FCA, CIP or DAP. Other commercial terms such as EXW or DDP are less suitable for this international traffic and tax issues are often difficult or even impossible to implement in reality. These Incoterms should only be used after close consultation with the specialist department or additionally fixed agreement.

## 6.2 Transport Responsibility of the Supplier for Incoterm DAP/ DDP

For a delivery contracted by the supplier, the supplier shall ensure and is responsible that

- the logistics service provider (LSP) contracted by them is able to provide information about the whereabouts of the goods,
- that the goods arrive on-time and in good condition at the SMP receiving factory or at the destination named by SMP.

If SMP and the supplier have agreed delivery according to the DAP/DDP terms, the supplier is obliged to obtain all the necessary information from SMP in good time and to ensure that an on-time and orderly arrival of the goods at the SMP receiving factory or the destination named by SMP can be guaranteed.

### 6.2.1 Loading and Unloading

The supplier, together with their LSP, must ensure that the goods are loaded safe for operation and transport. In addition, efficient and safe unloading at the receiving factory must be ensured. The supplier is obliged to obtain information from the receiving factory prior to the first delivery whether unloading is to take place by forklift truck from the side or over a ramp. They must ensure that the shipping agent uses the appropriate loading equipment for the on-site unloading method. Max. 45 minutes are available for loading and unloading.

### 6.2.2 Special Trips

Special transports (e.g. special trips, flights) are transports that differ from the standard procedure agreed in the delivery contract agreed between the supplier and SMP. They are to be implemented when there is a threat of delayed delivery dates due to late transfer to the freight carrier or for other reasons. The perpetrator of special trips must already be defined in the special trip agreement with the LSP.

If the supplier bears the responsibility for the regular transports, they are also responsible for handling the special trips.

For special trips, the drivers must be equipped with a mobile phone in order to be able to determine the whereabouts at any time on demand. The mobile phone number must be given to SMP on request. The supplier must guarantee 24/7 deliverability even on public holidays.

Special trips initiated by SMP require SMP's written consent and will only be paid by SMP when this written consent is enclosed with the invoice. Special trips without written consent by SMP shall be considered as not initiated by SMP.

The costs for special trips will be paid by the perpetrator.

## 6.2.3 Transport Carriers

If the supplier is responsible for the transports, they must ensure that transport carriers/equipment and crew/drivers are in a condition according to regulations.

The means of transport and equipment used for transport must be suitable for the respective weather conditions (e.g. winter tyres in winter) and equipped with appropriate aids for securing the load. The supplier must abide by the valid laws and take the latest state of the art into consideration.

## 6.3 Transport Responsibility at SMP for Incoterm EXW/ FCA

### 6.3.1 Notification to the Freight Carrier for Standard Trips

For a delivery ordered by SMP, the supplier is responsible both for the timely and correct notification of the TDL named by SMP (e.g. by a routing order) and for the on-time provision of the service scopes.

The working hours of the receiving factory as well as the Sundays and holidays relevant to transport must be considered for the delivery. The supplier must ensure that working hours and work-free or reduced working days at the supplier factory and the TDL have no influence on the delivery frequency.

Notification of shipment shall be sent by the supplier themselves by e-mail, fax or electronic data transfer to the TDL (i.e. freight carrier or shipping agent) appointed by SMP. Unless agreed otherwise, the form of the TDL freight carrier or shipping agent is used.

### 6.3.2 Loading and Unloading

The sender takes care of loading the goods onto the means of transport provided by the TDL/freight carrier. The sender is responsible for loading safe for transport. They must apply the latest state of the art and comply with the valid laws.

Insofar as no special loading plan was agreed in the logistics agreement, loading must be performed in such a way that efficient unloading is possible at the SMP factory.

The TDL/freight carrier is responsible for parking the vehicle and opening the truck tarpaulin or doors. The TDL must provide and perform the load securing so that safe transport can be guaranteed. The supplier is obliged to obtain information from the receiving factory prior to the first delivery whether unloading is to take place by forklift truck from the side or over a ramp. They must ensure that the shipping agent uses the appropriate loading equipment for the on-site unloading method. Max. 45 minutes are available for loading and unloading.

### 6.3.3 Shortfall

If the goods to be collected and provided are not available in the necessary quantity, the goods available and provided by the supplier shall be loaded. The supplier must inform the disposition department of the SMP factory of the detected shortfall immediately but before departure at the latest. The accompanying documents must be adapted by the supplier accordingly before collection.

SMP reserves the right to charge any costs incurred for the dead freight as well as the costs for transport of the shortfall to be delivered later by special trip to the supplier.



## 6.4 Transport Responsibility CIP Provision

The CIP provision is roughly a mixture of the FCA and DAP rulings.

Provision of goods and transfer of risk of the delivery follow the rules for FCA deliveries. The costs are based rather on the rules for DAP deliveries. In order to avoid disputes, the appropriate contract of purchase or delivery should define exactly which party is responsible for organising transport.

## 6.5 Loading Plan

If necessary - usually for several deliveries per day - the SMP factory will divide its requirements between the individual deliveries with the aid of a LOADING PLAN. The provision and loading of the goods for transports (FCA) or the delivery to the SMP factory (DAP or DDP) must be organised by the supplier according to this Loading Plan.

## 6.6 Transport Documents

The supplier must provide the following information when tendering their offer:

- \* goods designation
- \* statistical goods number
- \* country of origin, dispatch and trading

If the transport responsibility is with the supplier (DAP or DDP), the supplier must generate all the necessary transport documents per shipment at their own risk and cost and hand over or transfer these to the LSP/freight forwarder if necessary.

These are listed below:

### 6.6.1 Bond Note/Delivery Note

The necessary information in the bond note according to VDA 4912 are described in the SMP EDI Guideline. The bond note contains the data of the delivery note RDT according to VDA 4913.

If no bond note can be used in the individual case, e.g. for single special trips, the shipment must include a delivery note with the same data as on the bond note:

The original bond note must be affixed securely to the outside of the goods on the packaging (e.g. in a red envelope) for every shipment and may not be given to the transport company driver.

The supplier guarantees that the load goods match up to all the data in the bond note. If the bond note/delivery note is unavailable or incomplete on arrival of the goods at SMP, SMP reserves the option to return the goods to the sender at a charge.

If the bond note deviates from the delivery note RDT and/or the actually delivered quantity, SMP will send the supplier a complaint registering the current quantities.

The supplier must correct the invoice accordingly insofar as no credit note procedure is in operation.

### 6.6.2 Customs Documents

If the order or contract is awarded to a supplier based in the EU who, however, procure the goods from a third country, SMP has purchased customs-paid goods within the EU. The supplier must ensure that SMP does not appear as the customers declarer. The customs declaration and handling are performed by the supplier unless agreed otherwise in the contract of purchase.

If the order and contract is awarded to a supplier based in a third country (outside the EU), the sender must send all legally prescribed documents in accordance with 413 par. 1 German Commercial Code (invoice, packing list, freight bill and possibly preference documents or certificates of origin) to the LSP and in advance to the technical department/person technically responsible at SMP for the customs clearance.

SMP works together with a customs agent for the import declaration to ensure electronic customs handling.

The transport documents must be communicated or affixed clearly visibly to the goods according to legal regulations.

The driver also requires a CMR for overland transport (regardless from where).

Deliveries with T1 are permitted at the most in exceptional cases and by prior agreement with the technical department. Prior to delivery to the factory, a delivery with T1 must be driven to the appropriate customs office and customs declaration completed.

The following data are absolutely essential on the bond notes as well as the invoice and the packing list:

- Seller data/different collection address and contact data (mail/telephone)
- Buyer data/different delivery address
- Contact at SMP (mail/telephone), especially for development projects
- Specification of the order number/delivery plan number of SMP
- Project description
- Specification of the detailed goods description and SMP article number (only "plastic part" or "automotive part" is not permissible).
- Specification of the customs tariff code (HS code) for export from the country of shipment and import into the country of destination.
- Delivery agreement/Incoterm
- Specification of the correct goods values and the total value
- Number of packages as well as dimensions and gross/net weight

In addition, information must be provided that is necessary for official handling prior to delivery of the goods. This must be filled in completely and truthfully as required, e.g.:

- Transit declaration
- T1/T2 papers
- Carnet ATA/TIR
- Certificate of origin
- EUR.1
- ATR
- Goods traffic certificate (preference)
- Safety certificates/hazardous goods sheets
- Other documents as required

## 6.6.3 Freight Bill

Unless agreed otherwise, the freight bill must meet the recommendations of VDA 4922. The CMR freight bill must be used for international overland transports. Additional documents, for example AWB (Airway Bill) etc., are necessary for sea and air shipments.

## 6.7 Time Windows

Adherence to the time windows in the SMP factories and SMP module centres is binding for all regular transports and must be strictly observed. These are determined in the logistics data sheet.

The notification and collection dates specified in the shipping instruction must be observed for all deliveries and the delivery date must be noted on the shipping order/freight bill.

If the “Synchrosupply” time window system is in operation in the receiving factory, the suppliers are obliged to announce the planned deliveries, collections and possible changes.

Correct information regarding load quantities and time of arrival are necessary. The trip information (trip number, time, PIN) must be passed on to the truck driver. Complaints will be lodged if the time window is not adhered to (tolerance +/- 15 minutes, exception: information to the incoming inspection staff by the shipping agent/supplier) Complaints can also be lodged for incorrectly booked time windows with regard to the unloading point or load quantities.

The procuring factories ensure that all details regarding transport and distribution are clearly specified. Suppliers must question ambiguous or unclear instructions. Unapproved deviations from these distribution instructions may lead to the supplier being charged any fees for overfreight (including resulting administrative fees).

The supplier undertakes to start the loading/unloading process at their loading/unloading point within 30 minutes without interruption if no time window tool is in operation at the receiving factory. This time begins from the moment that the LSP/freight carrier contracted by SMP reports in to Incoming Goods.

If the time window was booked by Synchrosupply, the loading/unloading process must begin within 10 minutes. SMP will charge waiting times to the supplier.

## 6.8 Overdelivery/Underdelivery

Extra costs resulting from overdeliveries and underdeliveries will be charged to the perpetrator. Goods will be returned to the supplier not prepaid (see also chapter 8).

## 6.9 Late Deliveries and Delivery Default

The following measures must be taken if the supplier provides the goods too late for collection or delivers them too late:

- The responsible expeditors at SMP and at the LSP (freight carrier or shipping agent) must be informed immediately and by phone with subsequent confirmation by fax or e-mail.
- In this case, SMP cannot guarantee that there will be no wait times at SMP Incoming Goods.

- The supplier will take all the necessary measures for fastest possible provision of the components (emergency plan). All costs incurred (e.g. special transports) will be charged to the perpetrator.

### **6.10 NOK Parts**

If delivered parts do not meet the required and agreed quality requirements, they will be returned by SMP at the cost of the supplier. The supplier undertakes to make a replacement delivery in the time demanded by SMP (see also emergency plan).

If the supplier bears the responsibility for the regular transports, they are also responsible for handling the special trips. The supplier must explain the concept for handling special trips to SMP on request. The costs will be borne by the perpetrator.

### **6.11 Billing Interval**

The weekly billing will be compiled according to SMP specification.

SMP reserves the right to change over to a credit note procedure. SMP creates a credit note based on the weekly overview. In this case, 1.5% of the total sum will be retained for expenses.

## **7 Part Redemption**

If the supplier is still nominated as the supplier for the spare parts service in case of a discontinuation of a product in series business, the contract parties shall agree that any remaining material surpluses after the EOP can be bought back by the supplier.

Under consideration of this agreement, the supplier will be allowed to deliver complete packing units at EOP (see also 3.3). SMP will bear the costs for return transport.

## **8 Information Obligation**

The supplier is generally obliged to immediately (proactively) inform the respective SMP factory about any events which could affect the delivery or collection (e.g. production bottlenecks, accidents, traffic jams, adverse weather conditions, strike, etc.). Days on which the supplier will not be working such as public holidays or factory holidays must be reported to SMP by the supplier without demand at the beginning of the year.

It is extremely important that the relationship between SMP and our suppliers is based on an open, effective and foresighted communication. Products which do not meet the specifications, unauthorised changes or similar problems in the delivery chain constitute a risk for SMP and our customers if they are not effectively communicated and processed. The same applies for sub-suppliers and service providers in the delivery chain.

Suppliers must have a well thought out contingency plan in place to ensure a continuous flow of supplies even in the event of a disruption in operations and/or problems with material delivery due to personnel-related incidents, natural disasters, power outages, labor disruptions, equipment failures, or logistics failures. These contingency plans should be reviewed periodically. If suppliers determine that supply shortages may occur, they must immediately notify all SMP plants to be supplied.

## 9 Quality and Logistical Supplier Evaluation

The database for all supplier evaluations originates from a SAP excerpt. This SAP excerpt forms the basis for the SPES (Supplier Performance Management System).

The aim of the development and implementation of the Supplier Performance Management System is to measure and monitor the performance of existing suppliers in order to improve it with regard to quality, on-time delivery, price, total costs, general response time and services for SMP customers.

The supplier performance is evaluated based on operative and commercial parameters. The supplier's final mark is the sum of their operative performance (85%) and the commercial performance (15%). The supplier's operative performance depends on their quality performance (51%) and delivery performance (34%).

The logistical supplier evaluation consists of six parts:

<u>Part</u>	<u>Evaluation factor [%]</u>
Number of special trips	10
Overdelivery/early delivery	25
Underdelivery/late delivery	25
Logistical delivery quality	15
Response time	15
Soft Facts	10

### 9.1 Number of Special Trips

This is the monthly number of cases of special trips caused by the supplier. The supplier receives 0 points for every premium freight. Every occurrence of premium freights leads to 0%.

### 9.2 Overdelivery/Early Delivery

The monthly number of overdeliveries/early deliveries must be reported. The supplier can receive 0 to 25 points for overdeliveries or early deliveries depending on requirements.

Case 1: If the supplier delivers less than or equal 10 deliveries in one month.

Quantity of <b>NOK deliveries</b>	Points
0	25
1	6
>1	0

Case 2: If the supplier delivers more than or equal 10 deliveries in one month.

Quantity of <b>OK deliveries</b>	Points
100% - 95%	25
95% - 85%	15
85% - 66%	6
< 66%	0

### 9.3 Underdelivery/Late Delivery

The monthly number of underdeliveries/late deliveries must be reported. The supplier receives 0 to 25 points for underdeliveries/late deliveries, depending on the following factors:

Case 1: If the supplier delivers less than or equal 10 deliveries in one month.

Quantity of <b>NOK deliveries</b>	Points
0	25
1	6
>1	0

Case 2: If the supplier delivers more than or equal 10 deliveries in one month.

Quantity <b>OK deliveries</b>	Points
100% - 95%	25
95% - 85%	15
85% - 66%	6
< 66%	0

### 9.4 Logistical Delivery Quality

SMP demands a 100% logistical delivery quality. The following faults are evaluated for the analysis of the logistical delivery quality:

- IC02: (LF) Infringement of label instruction
- IC03: (LF) Wrong packaging
- IC09: (LF) Incorrect labelling
- IC16: (LF) Storage/transport soiling
- IC46: (LF) Special trips
- IC49: (LF) Wrong/missing revision state
- IC50: (LF) Leased goods account
- IC45: (LF) Outside Incoming Goods opening time
- IC37: (LF) Transport damage
- IC43: (LF) Delivery documents/RDT formally incorrect
- IC44: (LF) Delivery note quantity difference
- IC29: (LF) Wrong delivery
- IC38: (LF) Call-off over/underdelivery
- IC48: (LF) Delivery outside of time window
- IC51: (LF) Early/late delivery

- A complaint is generated per fault. SMP reserves the right to change costs incurred from the faults to the supplier. The costs are listed in the General Terms and Conditions of Purchase. The corrective measures must be provided in the format of the 8D report. All problem solution tools and the effectiveness of the corrective measures must be reported. 8D reports not created on time by the supplier will lead to another charge or complaint.

Quantity of <b>logistical fails</b>	Points
0	15
1	12
2	9
3	6
>3	0

## 9.5 Response Time

The monthly number of punctual, belated corrections of delivery problems (response time to 8D reports) must be reported.

The supplier receives 0 to 15 points for the response to delivery problems.

## 9.6 Informational Binding and Soft Facts

Informational binding is to be understood as the permanent and continuous fulfilment of the SMP EDI Guideline which is a co-applicable document of the logistics standard.

The awarding of Soft Facts points depends on the fulfilment of the following criteria: Response time/behaviour, info behaviour, availability/representation, project openness and 24/7 hotline.

## 9.7 Self-evaluation based on Global MMOG/LE

The 'Logistics Evaluation' is based on the 'Global Materials Management Operations - Guidelines'. It enables the evaluation of the logistic capabilities of a supplier based on a multiple-choice questionnaire.

The suppliers can do the evaluation themselves. The effective use assumes truthful and as objective as possible answering of the questions.

The Logistics Evaluation enables an estimation of the existing risks regarding the future supply security. With regard to a cooperative partnership, a mutual analysis of this partnership is a must. Here, it is less a question of evaluating individual details but rather of determining the important fields of action for improving the performance of the suppliers.

The questionnaire can be taken from the German translation of the SMP Internet site. Further information can also be found under [www.odette.org](http://www.odette.org). The Logistics Evaluation must be made at the beginning of the project and on demand by SMP. To what extent the GMMOG/LE is carried out, completely or only partly, depends on the inquired or awarded project scope. An annual evaluation is obligatory for the customers Ford and GM.

## 10 Logistic Offer Preparation

### 10.1 Definition and Delimitation A Price, B Price and Logistics Costs

The A price contains the total handling expenses, all necessary quality assurance measures as well as the administrative activities up to the time of transfer according to the terms of delivery Incoterms® 2020 FCA “free carrier” (...named location).

Incoterms® 2020 FOB “free on board” (... named port of shipment) applies instead of FCA for international suppliers (sea freight).

The border between the A and B price is defined by the location of the last added value.

The B price is made up of the A price + logistics costs.

The logistics costs include, in addition to the freight costs, the load carrier costs as well as any costs for external storage and handling.

### 10.2 Elements of the A Price

The A price contains the total processing costs, all necessary quality assurance measures as well as the administrative activities up to the place of transfer according to the delivery terms Incoterms® 2010 FCA "Free Carrier" (...specified storage place).

#### 10.2.1 Handling Expenses

The handling expenses include especially:

- Packing in load carrier (container, box)
- Clear identification of the parts or load carriers and load units according to the SMP EDI Guideline
- Loading of the load unit onto the freight carrier

#### 10.2.2 Quality Assurance Measures

The quality assurance measures include especially:

- Cleaning the load carrier (also removal of labels)
- Preservation
- Packed including part protection (quality assurance measure/not reusable\*)
- Consideration of the technical terms of delivery (part protection, preservation)
- Provision of commercially available disposable packaging

#### 10.2.3 Administrative Activities

The administrative activities include:

- The necessary data exchange for the delivery process (receipt, dispatch)
- Generation of all shipment documents and other costs (customers declaration, etc.)



\*Part protection: Load carrier padding, intermediate layers, dust covers, sealing plugs, polythene bags, transport locks, paper, disposable packs, blister packages, adhesive film, bubble wrap, filling material

All pre-logistic costs (e.g. transport and load carrier costs for raw and pre-materials) are part of the A price.

## 10.3 Elements of the Logistics Costs

The logistics costs include, in addition to the freight costs, the load carrier costs as well as any costs for external storage and handling.

### 10.3.1 Freight Costs

- Full container transport including all ancillary costs (costs FCA from the supplier site/FOB port of shipment up to the point of transfer in the supplier's delivery location up to DDP receiving factory SMP)
- Empty container transport including all ancillary costs (FCA from the SMP delivering factory to the supplier's delivery location)

## 10.4 Load Carrier Costs

- Planning and development of the load carriers
- Investment in or leasing of the load carriers
- Maintenance
- Overseas packaging
- Other required load carrier protective packaging (disposable protection if necessary)

### 10.4.1 Costs for External Storage and Handling

- Unloading
- Repacking in the load carriers agreed with SMP (possibly in disposable packaging for overseas deliveries)
- Consignment and sequencing
- Storage
- Transport and provision up to the point of transfer according to term of delivery

10.5 B Price Inquiry Process

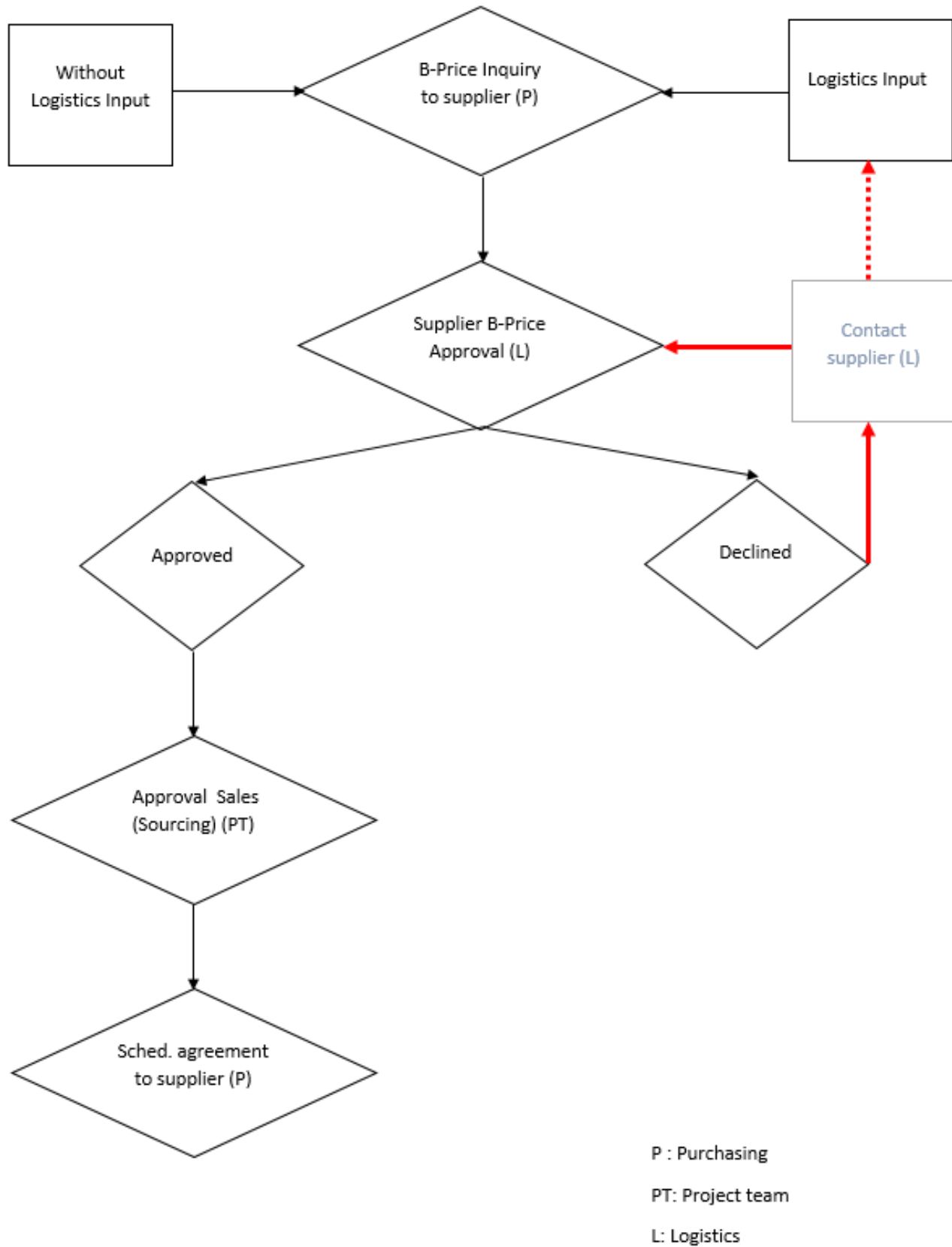

10.6 Composition of A and B Price without Use of Regional Warehouse

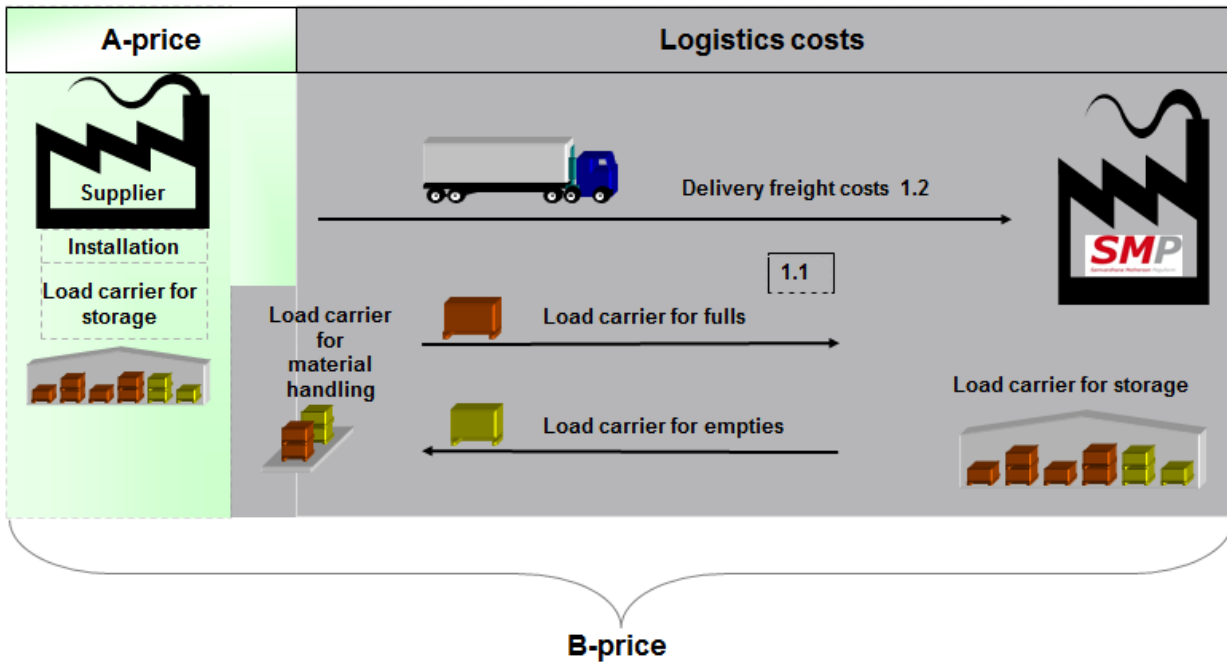

10.7 Composition of A and B Price with Use of Regional Warehouse

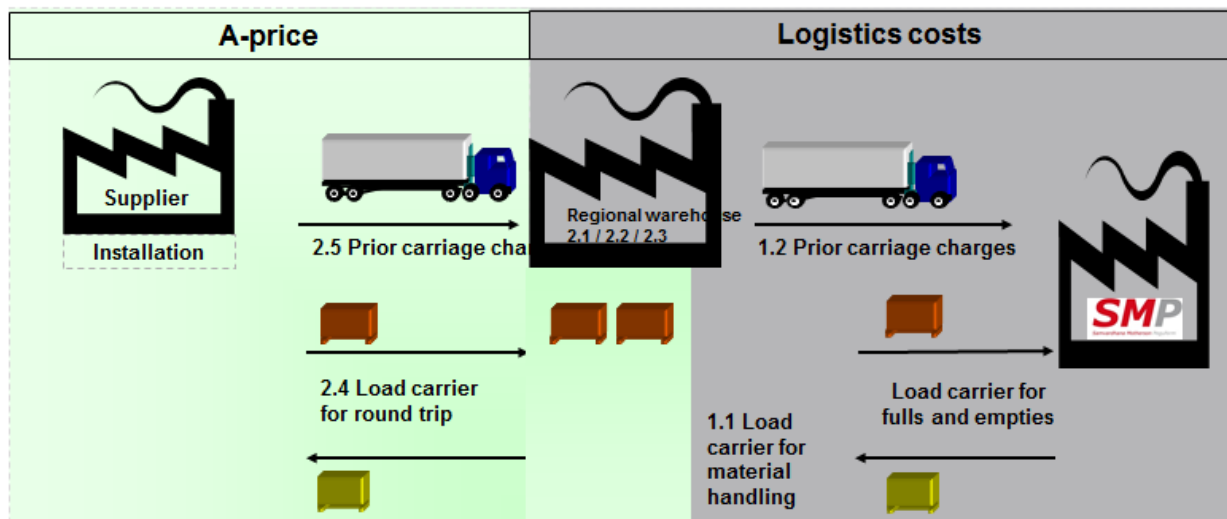

➔ The load carrier for the round trip in conjunction with the prior carriage charges as well as for storage and regional warehouse are a part of the A-price.

The individual components should be specified in the costing sheet.

## 11 Other Documents

The following other documents are part of the Logistics Standard:

- Logistics costs calculation sheet
- Packaging directive
- Load carrier catalogue:
- Packaging data sheet
- EDI Guideline
- Odette recommendation Global MMOG/LE

After order placement additionally:

- Logistics data sheet
- Shipping instruction (for FCA ruling)
- Communication data sheet (EDI data sheet)
- Packaging directive VSC
- Packaging directive Schierling

## 12 Terms and Abbreviations

DELIVERY	Transfer of ownership to the legitimised RECIPIENT. This presumes the acceptance by the RECIPIENT after prior incoming inspection or demand by the supplier to perform this incoming inspection.
SENDER:	The individual or company who actually transfers the goods to the freight carrier - not the contracting party of the freight carrier.
EDI:	Electronic Data Interchange
RECIPIENT:	The individual or company (address) specified in the shipping order or transport document to which the goods are to be delivered.
DELORD:	EDIFACT notification: With this type of notification, the individual KANBANS are transferred to the suppliers in the form of a quantity call-off.
FREIGHT CARRIER:	The individual or company performing the transport of goods on land, by water and by air.
GOODS:	All products that SMP procures from their suppliers, including their appropriate LOAD CARRIERS or other PACKAGING MEANS, empty containers, packaging material or outer packagings.
INCOTERMS® 2020	= International Commercial Terms are uniform international rules for the construction of commercial contract formulae in international goods trade by the International Chamber of Commerce in Paris. They regulate the rights and obligations of the seller and the buyer inter alia the distribution of costs and the transfer of risk, the procurement of documents and the transfer of obligation for care and disposition.
LOAD CARRIER.	A means for carrying goods combined in a load unit. The term LOAD CARRIER also covers the common term “container” or also the packaging means “carton” (box). A synonymous term is also loading means.
EMPTIES:	Emptied reusable packagings or loading means which are to be returned to the LOADING POINT by the supplier as part of a transport.
CALL-OFF:	Non-binding preview of the orders from the OEM usually for 6 months on a weekly basis which is then passed on to the suppliers regularly by fax or EDI.
DELIVERY TIME:	Time between ordering and delivering the goods
LOADING PLAN:	Binding quantity and part number division of the order among individual deliveries
OEM:	Original Equipment Manufacturer – first equipper, automotive manufacturer
PRODUCTION CAPACITY:	Capability of a supplier to supply a defined number of components over a certain time period (hour, day or week).
SHIPPING AGENT:	The individual or company organising the transport service, i.e. buying traffic and associated services and individuals or companies assisting them (by their own services if required) who plan, control, optimise and inspect the transports and logistic services and sell these to SMP as a full service.
SPES	Supplier Performance Evaluation System, evaluation portal for Purchasing (15%), Quality (51%) and Logistics (14%).

TRANSPORT:	Conveyance (physical movement) of goods in one or more stages/trips with one or more means of transport, starting with the stowing and securing of the goods safe for transport on the means of transport at the point of transfer up to delivery to the RECIPIENT.
VDA	Association of the German Automotive Industry